

# User's Manual

## PMM 3000

### WIDEBAND RF SIGNAL GENERATOR

10 kHz - 1000 MHz

#### **SERIAL NUMBER OF THE INSTRUMENT**

You can find the Series Number on the rear panel of the instrument.

Series Number is in the form: 0000X00000.

The first four digits and the letter are the Series Number prefix, the last five digits are the Series Number suffix. The prefix is the same for identical instruments, it changes only when a configuration change is made to the instrument.

The suffix is different for each instrument.

**NOTE:**

If the instrument is used in any other way than as described in this Users Manual, it may become unsafe

Before using this product, the related documentation must be read with great care and fully understood to familiarize with all the safety prescriptions.



To ensure the correct use and the maximum safety level, the User shall know all the instructions and recommendations contained in this document.

This product is a **Safety Class I** and **Installation Category II** instrument according to IEC classification and has been designed to meet the requirements of EN61010-1 (Safety Requirements for Electrical Equipment for Measurement, Control and Laboratory Use).



This product has a **Pollution Degree II** normally only non-conductive pollution occurs. Occasionally, however, a temporary conductivity caused by condensation must be expected.

The information contained in this document is subject to change without notice.

**KEY TO THE ELECTRIC AND SAFETY SYMBOLS:**

 You now own a high-quality instrument that will give you many years of reliable service. Nevertheless, even this product will eventually become obsolete. When that time comes, please remember that electronic equipment must be disposed of in accordance with local regulations. This product conforms to the WEEE Directive of the European Union (2002/96/EC) and belongs to Category 9 (Monitoring and Control Instruments). You can return the instrument to us free of charge for proper environment friendly disposal. You can obtain further information from your local Narda Sales Partner or by visiting our website at [www.narda-sts.it](http://www.narda-sts.it).



Warning, danger of electric shock



Earth



Read carefully the Operating Manual and its instructions, pay attention to the safety symbols.



Unit Earth Connection



Earth Protection



Equipotential

**KEY TO THE SYMBOLS USED IN THIS DOCUMENT:**



**DANGER**

The **DANGER** sign draws attention to a potential risk to a person's safety. All the precautions must be fully understood and applied before proceeding.



**WARNING**

The **WARNING** sign draws attention to a potential risk of damage to the apparatus or loss of data. All the precautions must be fully understood and applied before proceeding.



**CAUTION**

The **CAUTION** sign draws attention against unsafe practices for the apparatus functionality.



**NOTE:**

The **NOTE** draw attention to important information.

# Contents

<b>General safety considerations and instructions.....</b>	<b>Page</b> V
<b>EC Conformity Certificate.....</b>	VI
<b>1 General Information</b>	<b>Page</b>
1.1 Documentation.....	1-1
1.2 Introduction .....	1-1
1.3 Instrument items.....	1-1
1.4 Optional accessories.....	1-1
1.5 Main specifications.....	1-2
1.6 Front and rear panel.....	1-3
1.7 Functional description.....	1-4
<b>2. Installation</b>	<b>Page</b>
2.1 Introduction.....	2-1
2.2 Initial inspection.....	2-1
2.3 Packing and unpacking.....	2-1
2.4 Preparation for use.....	2-1
2.5 Installation check list.....	2-1
2.6 Line voltage selection.....	2-2
2.7 Fuse selection.....	2-2
2.8 Power cable.....	2-2
2.9 Environment.....	2-2
2.10 Return for service.....	2-2
2.11 Equipment cleaning.....	2-3
2.12 Hardware installation.....	2-3
<b>3 Operation instructions</b>	<b>Page</b>
3.1 Starting PMM 3000.....	3.1
3.1.1 Main menu display.....	3.1
3.1.2 Frequency setting.....	3.1
3.1.3 Level setting.....	3.2
3.1.4 RF ON/OFF.....	3-2
3.1.5 To enable the modulation.....	3-2
3.1.6 Modulation choice.....	3-3
3.2 Setting RS-485 address.....	3-4
3.2.1 Selecting the Unit.....	3.4
3.2.2 Unit mode of operation.....	3.4
3.2.3 Selecting units.....	3.4
3.3 Scan Mode of operation.....	3-5
3.4 List of tables.....	3-5
3.5 NULL Table – Using a table.....	3-5
3.6 Starting a sweep.....	3-6
<b>4 Programming</b>	<b>Page</b>
4.1 Introduction.....	4-1
4.2 Communication.....	4-1
4.3 Protocol.....	4-1
4.4 Address.....	4-1
4.5 Format.....	4-1
4.6 PMM 3000 commands.....	4-2
4.6.1 Frequency programming.....	4-2
4.6.2 Modulation programming.....	4-2
4.6.3 Level programming.....	4-2
4.6.4 RF OFF and RF ON.....	4-2

---

## Figures

---

Figure		Page
1-1	Front panel.....	1-3
1-2	Rear panel.....	1-3
1-3	Block diagram of the PMM 3000.....	1-4

## Tables

---

Table		Page
1-1	Main Specifications.....	1-2



## **SAFETY RECOMMENDATIONS AND INSTRUCTIONS**

This product has been designed, produced and tested in Italy, and it left the factory in conditions fully complying with the current safety standards. To maintain it in safe conditions and ensure correct use, these general instructions must be fully understood and applied before the product is used.

- When the device must be connected permanently, first provide effective grounding;
- If the device must be connected to other equipment or accessories, make sure they are all safely grounded;
- In case of devices permanently connected to the power supply, and lacking any fuses or other devices of mains protection, the power line must be equipped with adequate protection commensurate to the consumption of all the devices connected to it;
- In case of connection of the device to the power mains, make sure before connection that the voltage selected on the voltage switch and the fuses are adequate for the voltage of the actual mains;
- Devices in Safety Class I, equipped with connection to the power mains by means of cord and plug, can only be plugged into a socket equipped with a ground wire;
- Any interruption or loosening of the ground wire or of a connecting power cable, inside or outside the device, will cause a potential risk for the safety of the personnel;
- Ground connections must not be interrupted intentionally;
- To prevent the possible danger of electrocution, do not remove any covers, panels or guards installed on the device, and refer only to NARDA Service Centers if maintenance should be necessary;
- To maintain adequate protection from fire hazards, replace fuses only with others of the same type and rating;
- Follow the safety regulations and any additional instructions in this manual to prevent accidents and damages.

## EC Conformity Certificate

(in accordance with the directives: EMC 89/336/EEC and low voltage 73/23/EEC)

This is to certify that the product: PMM 3000 Wideband RF Signal Generator 10 kHz - 1 GHz

Produced by: NARDA S.r.l.  
Safety Test Solution  
Via Benessea 29/B  
17035 Cisano sul Neva (SV) - ITALY

complies with the following European Standards

Safety: EN 61010-1:1993 + A2:1995

EMC: EN 55011 - EN 61000-3-2 - EN 61000-3-3 - EN 50082-1

This product complies with the requirements of the Low Voltage Directive 73/23/EEC, amended by 93/68/EEC, and the EMC Directive 89/336/EEC amended by 92/31/EEC, 93/68/EEC, 93/97/EEC.

NARDA S.r.l.

---

# 1 - General Information

---

## 1.1 Documentation

Enclosed with this manual are:

- a service questionnaire to send back to NARDA in case of equipment service is needed
- an accessories check list to verify all accessories enclosed in the packaging.

## 1.2 Introduction

PMM 3000 is a wide band RF signal generator covering from 10 kHz to 1000 MHz frequency range. The generator is fully automatic and programmable via RS232/485 serial port. Due to his performances it is an ideal tool for all EMC immunity test applications.

The instrument has several features not even included into high cost generator such as: internal pulse modulation, sweeping and correction table downloading.

## 1.3 Instrument items

The PMM 3000 includes the following items:

- RF signal generator;
- N-Bnc adapter
- RS232 cable;
- RS232 adapter 9-25 pin;
- Power supply cable;
- Operating Manual.

## 1.4 Optional accessories

PMM 3000 can be used with several accessories.

The possible options are:

- PMM 6000N RF 10W(15W) amplifier 9 kHz - 230 MHz;
- PMM 6600 RF Power meter for EMC application;
- PMM 6600D Slave power meter;
- M75 IFI 75W, 10 kHz - 230 MHz;
- F-203I-23 Injection Clamp;
- F-203I-23-DCN Decoupling Network;
- F-120-9A Injection Probe;
- F-33-1 Current Monitor;
- Wide range of CDNs;
- 150-50 Calibration kit for CDNs;
- Load-50 50 Ohm load;
- 6 dB, 50 Ohm fixed attenuators, 10, 15, 30, 100 W;
- Coupling/Decoupling Networks;
- EM current injection clamp
- RF power meter;
- PMM SW06 Immunity software for IEC 1000-4-6 and ENV50141.

### 1.5 Main specifications

Table 1-1 lists the PMM 3000 performance specifications.

The following conditions apply to all specifications:

- The PMM 3000 needs at least a 15 minutes warm-up before to operate.
- The ambient temperature shall be from 10°C to 50°C

**TABLE 1-1 Technical specifications**

<b>Frequency Range</b>	10 kHz to 1 GHz
<b>Resolution</b>	1 kHz (freq. < 100 MHz), 10 kHz (freq. > 100 MHz)
<b>Accuracy</b>	± 50 ppm
<b>Level Range</b>	- 80 to + 10 dBm
<b>Resolution</b>	0.1 dB
<b>Accuracy</b>	± 1 dB
<b>Level flatness</b>	± 1 dB
<b>Output impedance</b>	50 Ω
<b>Connector</b>	N (female)
<b>Spectral purity</b>	
<b>Harmonic</b>	< - 30 dBc for level @ 0 dBm
<b>Non harmonic</b>	< - 50 dBc
<b>AM modulation</b>	
<b>Internal</b>	400 or 1 kHz at 80%
<b>External</b>	100 Hz to 10 kHz max. 90%
<b>Input impedance</b>	> 1 kΩ
<b>Connector</b>	BNC female (Absolute maximum rating 10Vpp)
<b>Pulse modulation</b>	
<b>Internal</b>	200 Hz
<b>ON/OFF ratio</b>	@ 100 MHz > 70 dB, @ 900 MHz > 40 dB
<b>Frequency accuracy</b>	± 10%
<b>Pulse mod. 1 Hz</b>	
<b>Internal</b>	1 Hz
<b>ON/OFF ratio</b>	@ 900 MHz, 0 dBm > 70 dB
<b>Frequency accuracy</b>	± 10%
<b>Remote control</b>	
<b>System interface</b>	RS-232/485
<b>Connector</b>	DB9
<b>User port</b>	RF Off, Start/stop test, RF-ON
<b>Display</b>	4 lines LCD
<b>Power supply</b>	
<b>AC</b>	115/230 VAC, 30 VA, 50-60 Hz
<b>DC</b>	22-26 VDC
<b>Size</b>	257 x 110 x 315 mm (WxHxD)
<b>Weight</b>	4.5 kg



## 1.6 Front and rear panel

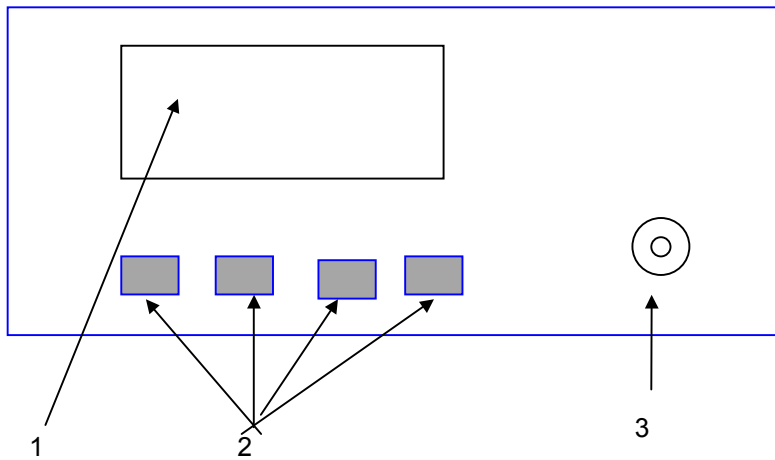

**Fig. 1-1** Front Panel

**Legend:**

- 1.- LCD display
- 2 - Functional keys
- 3 - RF output connector

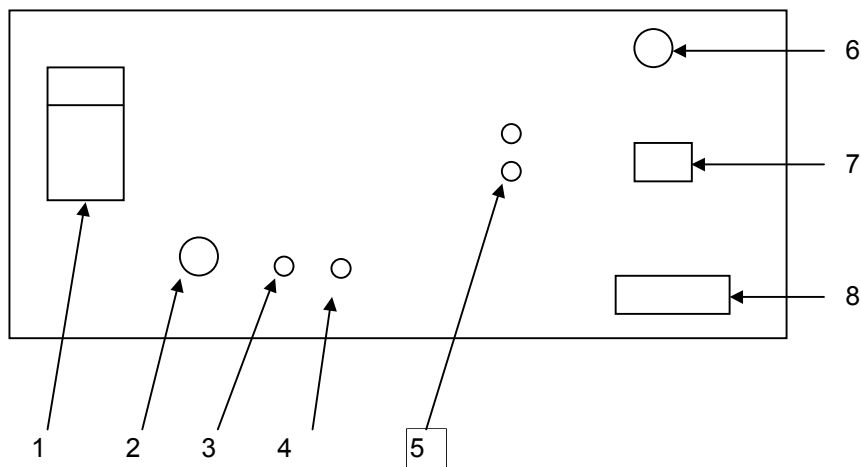

**Fig. 1-2** Rear Panel

**Legend:**

- 1.- Mains plug
- 2 - voltage selector
- 3 - ground lead
- 4 - DC input power
- 5 - RX- TX leds
- 6 - External AM modulation
- 7 - RS232/485 interface
- 8 - User I/O port

### 1.7 Functional description

PMM 3000 philosophy is based on high technology approach to offer high performance into small instrument. The block diagram give you an idea how it works.

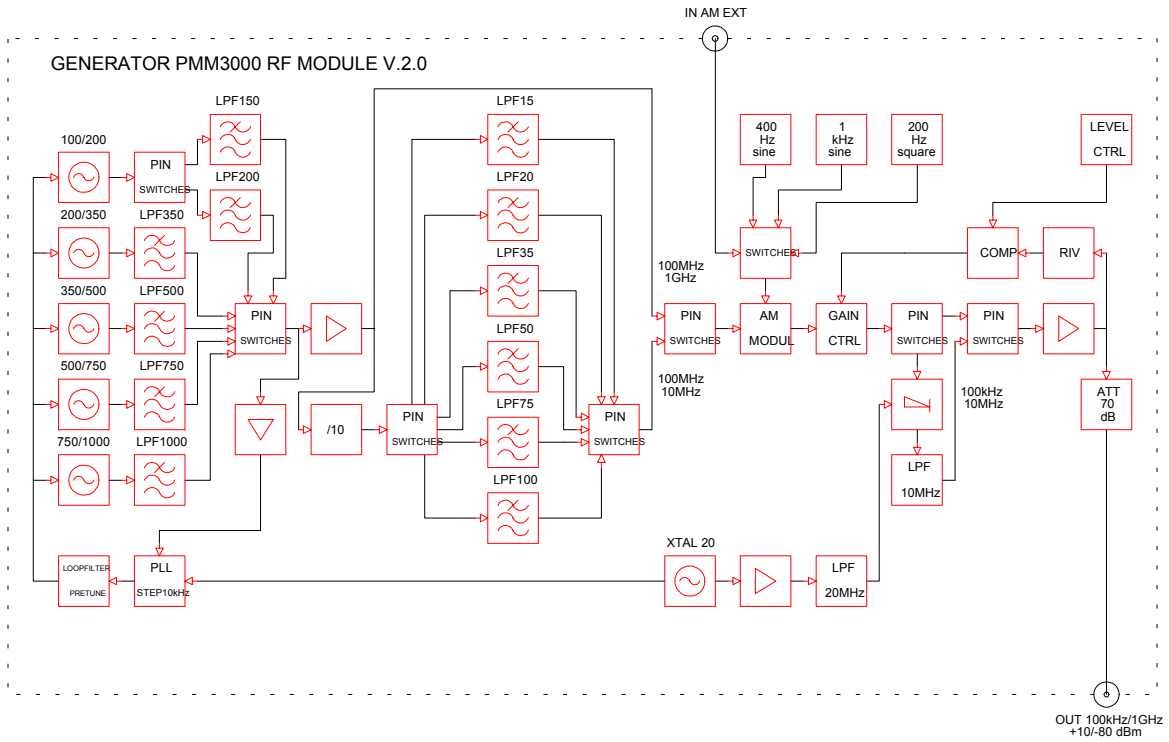
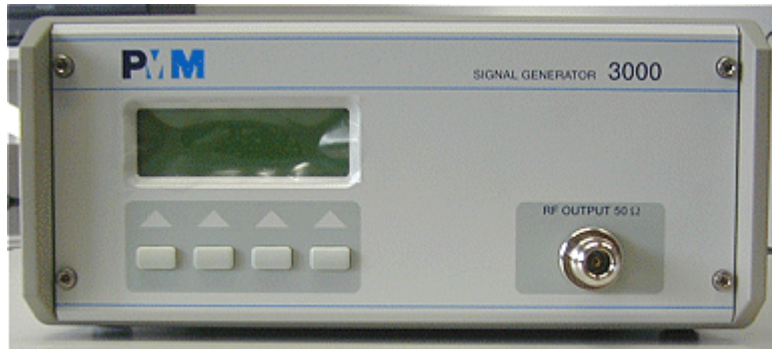

Fig. 1-3 Block diagram of the PMM 3000



## 2 - Installation

### 2.1 Introduction

This section provides the information needed to install your PMM 3000. Included is information pertinent to initial inspection, power requirements, line voltage and fuse selection, power cables, interconnection, environment, instrument mounting, cleaning, storage and shipment.

### 2.2 Initial inspection



**WARNING**

**To avoid hazardous electrical shock, do not turn on the instrument when there are signs of shipping damage to any portion of it.**

### 2.3 Packing and Unpacking

Inspect the shipping container for damage.

If the shipping container or cushion material is damaged, it should be kept until the contents of the shipment have been checked for completeness and the instrument has been checked mechanically and electrically.

Verify the accessories availability in the shipping referring to the accessories check list enclosed with the Users Manual.

Notify any damage to the carrier personnel as well as the NARDA Representative.

### 2.4 Preparation for use



**WARNING**

**This is a Safety Class I equipment, it is provided with a protective earth terminal. An uninterruptible safety earth ground must be provided from the main power source to the product input wiring terminals through the power cable (or supplied power cable set). Verify the safety earth ground functionality before operation.**

### 2.5 Installation Check list

Before operation the following steps shall be taken:

- Check the line voltage to ensure the compatibility with the equipment settings.
- Verify that the fuse rating is appropriate for the line voltage used.



**CAUTION**

**Before plugging PMM 3000 into the main supply line ensure that the line voltage is in the range specified, and that the appropriate fuse have been selected.**

**2.6 Line voltage selection**

The line voltage can be changed from the rear panel switching the rotary switch to the right voltage according to your mains.

**2.7 Fuse selection**

Line Voltage	Fuse Rating	Type
90 ÷ 135 V	T 250 mA	T (Time delay slow-blow)
175 ÷ 264 V	T 125 mA	T (Time delay slow-blow)



**WARNING**

Before connecting this instrument, ensure that an uninterruptible safety earth ground is provided from the main power source to the product protective earth connection. If this instrument is to be connected to other equipment or accessories, prior to energizing either unit verify that a common ground exists between them. Any interruption or loosening of the protective earth ground conductor, either inside or outside the unit or in an extension cable will cause a potential shock hazard that could result in personal injury.

**2.8 Power cable**

This instrument is equipped with a three wires power cable. When connected to an appropriate AC power receptacle, this cable grounds the instrument chassis.

**2.9 Environment**

The operating environment is specified to be within the following limitations:

- Temperature +10° to +40° C
- Humidity < 90% relative
- Altitude < 4000 meters

The instrument should be stored in a clean, dry environment

The storage and shipping environment is specified to be within the following limitations:

- Temperature -40° to + 50° C
- Humidity < 95% relative
- Altitude < 15000 meters

**2.10 Return for service**

If the instrument should be returned to NARDA for service, please complete the service questionnaire enclosed with the Users Manual and attach it to the instrument.

To minimize the repair time, be as specific as possible when describing the failure. If the failure only occurs under certain conditions, explain how to duplicate the failure.

If possible, reuse of the original packaging to ship the equipment is preferable.

In case other package should be used, ensure to wrap the instrument in heavy paper or plastic.

Use a strong shipping container and use enough shock absorbing material around all sides of the equipment to provide a firm cushion and prevent movement in the container.

To prevent damage during shipment in particular protect the front panel.

Seal the shipping container securely.

Mark the shipping container FRAGILE to encourage careful handling.

**2.11 Equipment cleaning** Use a non abrasive clean, soft and dry cloth for equipment cleaning.

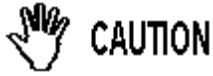

**To clean the equipment do not use any solvent, thinner, turpentine, acid, acetone or similar matter to avoid damage to external enclosure.**

**2.12 Hardware  
Installation**

PMM 3000 is delivered ready to use. Remove the signal generator from his cardboard box and connect power cable to rear panel mains plug. Push the main switch to "ON" position and wait few seconds. Then PMM 3000 is ready to use.

This page has been left blank intentionally

## 3 - Operation instructions

### 3.1 Starting PMM 3000

PMM 3000 has been designed with a user friendly interface to be used by EMC engineer as well by non-skilled personnel.

#### 3.1.1 Main menu display

All functions can be recalled by the four functional keys located on the bottom of LCD display. When instrument is turned on the firmware initiate the internal testing procedure. If everything is OK, the display will show:

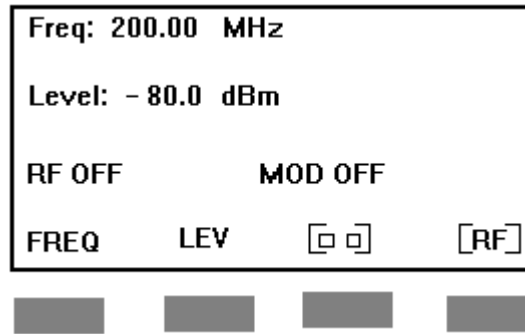

The main commands are:

- FREQ** to select the RF frequency
- LEV** to select output level
- [□ □]** to select the second commands row
- RF** to turn On or Off the output power

#### 3.1.2 Frequency setting

Activating the function key under the FREQ you will enter the frequency menu that shows:

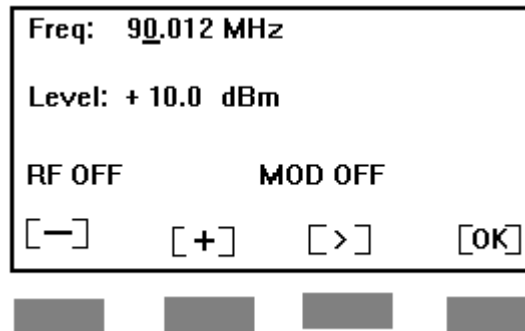

To change the frequency value you should position the cursor under the decimal you want to change; then using the key [-] or [+] you can decrease or increase the value. When done confirm the selection pushing [OK] button.

IF you keep the [-] or [+] key depressed the selected value will decrease or increase automatically.

### 3.1.3 Level setting

Activating the function key under the **LEV** you will enter the level menu that shows:

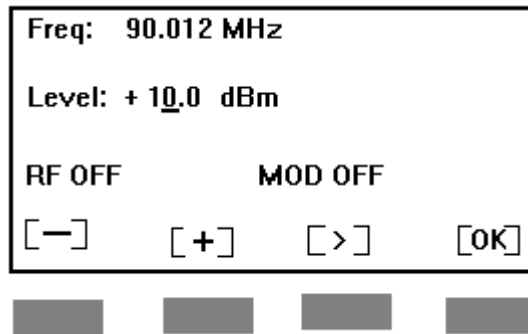

To change the output level value you should position the cursor under the decimal you want to change; then using the key [-] or [+] you can decrease or increase the value. When done confirm the selection pushing [OK] button.

### 3.1.4 To enable the RF output

Pushing the RF function key you turn On or OFF the generator. The display will be:

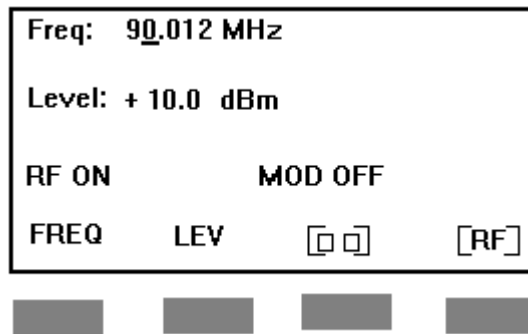

### 3.1.5 To enable the modulation

To modulate the RF output you should enter the modulation menu. From the main menu you must push [□ □]. The display will show:

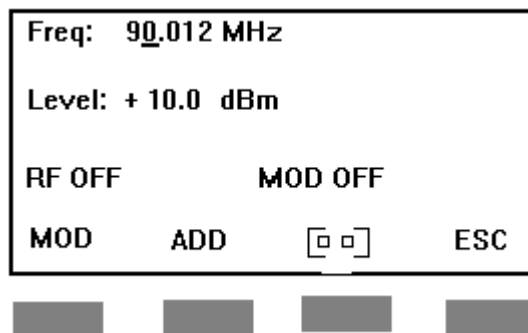



Where the functions have the following meaning:

- **MOD** to enable modulation mode
- **ADD** to define RS485 address
- **[□□]** to go to third command row
- **ESC** to go back to main menu

**3.1.6 Modulation choice** Activating the function **MOD** the display will show all the modulation capabilities.  
The menu will be:

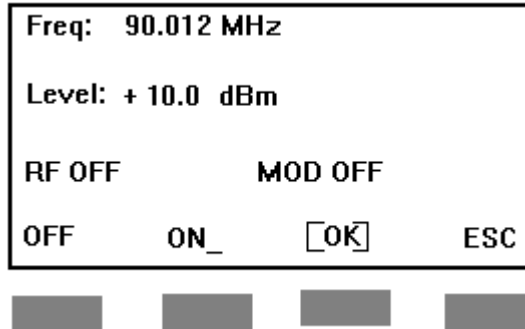

Pushing the key **ON\_** you can go through the following choices:

- MOD 400 Hz
- MOD 1 kHz
- MOD PULSE
- 1 Hz PULSE
- MOD EXT

Confirm your choice pushing OK. Pushing ESC you exit modulation mode of operation.

### 3.2 Setting RS-485 address

With the key **ADD** you can change the RS-485 address. Activating it, the menu will be:

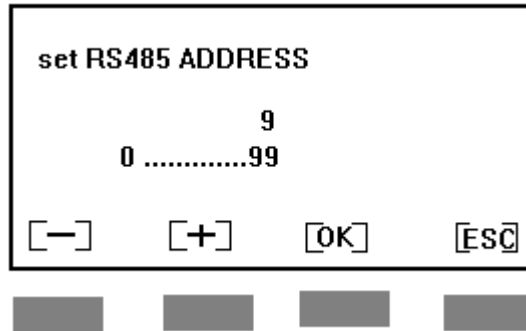

#### 3.2.1 Selecting the Unit

Use key [-] or [+] to increase or decrease the address.  
Push OK to confirm.  
Push ESC to exit ADDRESS mode of operation.

#### 3.2.2 Unit mode of operation

From main menu activating twice the button [□□] you enter the menu for changing the Unit and to use SCAN mode of operation. The display will show:

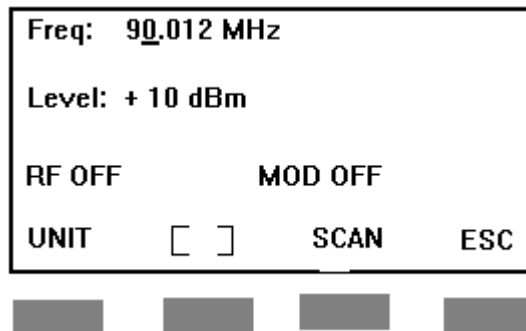

#### 3.2.3 Selecting units

Pressing UNIT you get the following choices:

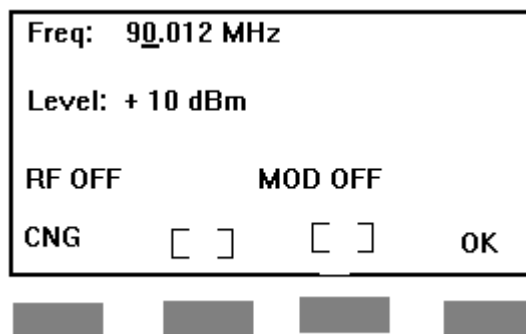

Pushing the **CNG** button you switch the unit from dBm to dBμV.  
Push OK to confirm.

### 3.3 SCAN mode of operation

PMM 3000 allows you to run immunity tests without to be controlled by any PC. Using our immunity software SW02 (radiated) or SW06 (conducted) you can download from the PC up to three different correction tables. For example, the three test level according to your Standard.

From main menu, pushing twice the [ ] button you can enter the SCAN mode of operation. Pushing SCAN button the display will be:

### 3.4 List of tables

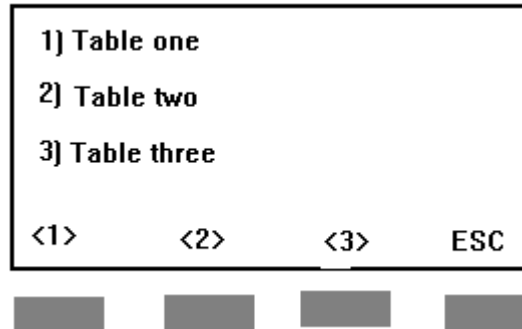

The above display examples shows the case where three different tables have been loaded. The name of the tables 1), 2) or 3) have been transferred from our software automatically. You can not change them from PMM 3000 keyboard.

### 3.5 NULL Table Using a table

When you select a **NULL Table** no action is taken.

Selecting one of the three tables you get the following display with all commands to perform the sweeping over a frequency range defined by the selected table. The display will be:

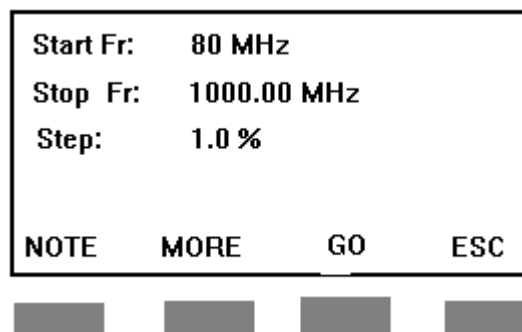

The new functions are:

- **NOTE** shows the table comment defined during table creation
- **MORE** shows the other table parameters (i.e. dwell time, limit, modulation)
- **GO** to start the sweep
- **ESC** to go to the previous menu

### 3.6 Starting a sweep

Activating the “GO” command PMM 3000 will start sweeping using all parameters defined into the transferred table. The display will shows:

Freq:	80 MHz		
Level:-	17.2 dBm		
RF ON	MOD 1 kHz		
*****	HALT	*****	STOP



The sweepings can be halted with **HALT** command and then the user can manually change all the RF generator parameters. Using **STOP** you can definitely stop you sweep.

When pressing **HALT** the user can continue form the nearest frequency associated with the table and the software will use same level defined into the table.

## 4 - How to program

### 4.1 Introduction

PMM 3000 has been designed to be programmed through his serial port using either RS232 as well RS485.

When using RS232 you can use only one instrument connected to PC serial port. If using RS485 you can connect up to 31 instruments to the same PC serial port.

PMM 3000 uses the same connector for both communications.

### 4.2 Communication

Half duplex communication is implemented. The logical levels are identical for RS232 and RS485.

A built-in automatic tool identify the type of communication used and shows it on LCD display. Typical communication is implemented at 9600 baud with 8 bit, one stop bit and no parity.

### 4.3 Protocol

Be aware that only the PC can send the commands. PMM 3000 will answer when is inquired only.

Communication is done at 9600 Baud with 8 bit, 1 stop bit and no parity.

The communication uses strings with variable byte width. The characters used inside the strings are in ASCII format (00 - 127) at 7 bit. The most significant bit are ignored in reception and put to 0 during transmission.

Every strings starts with the special character “#” and stops with “\*”.

### 4.4 Address

When you drive PMM 3000 via RS485 the address is embedded with the two digit following the first character “#”.

The address can be assigned from 01 to 99. When using RS232 this two character are ignored.

The host computer does not have any address because it can receive the message only. Therefore there is no direct communication between host and the instruments.

In order to impose the address to PMM 3000 you should follow the procedure described on pag. 3-4.

### 4.5 Format

All messages are content between “#” and “\*” characters for strings send to Host PC and between “address” and “\*” for strings send to the instrument.

The string sent to the PMM 3000 has the following format: “#iic.c\*”.

Where:

- # Start character
- ii RS485 address
- c..c Command
- \* End character

PMM 3000 will respond with the following string: - “#c..c”. In this case the address is not used because the PC does not need it.

Between “C..C” there is the message text where the length can varies from 1 to 100 characters.

**4.6 PMM 3000 commands** The following are the commands that PMM 3000 can understand or gives back to PC:

- #00V\* request to send back to PC the type of generator in use
- #00v\* request to send back to PC the revision number
- #00F<freq>\* send the frequency value in MHz
- #00?f\* request to send back to PC the actual frequency.  
The answer will be:  
"F.<freq>MHz".
- #00M4\* to enable 400 Hz modulation
- #00M1\* to enable 1 kHz modulation
- #00Me\* to enable external modulation
- #00Mp\* to enable Pulse modulation
- #00M5\* to enable 1 Hz Pulse modulation
- #00M0\* to disable all modulation
- #00?m\* request to send back to PC which type of modulation is present.

The possible answers are:

- "MOD:1" 1 kHz modulation
- "MOD:4" 400 Hz modulation
- "MOD:p" Pulse modulation
- "MOD:5".....1 Hz Pulse modulation
- "MOD:e" external modulation
- "MOD:0" NO modulation

- 4.6.3 Level programming** • #00L<lev> to set the output level in dBm
- #00?L" request to send back to PC the actual level.

The answer will be:

"Lev:<lev>dBm"

- 4.6.4 RF OFF and RF ON** • #00R0\* to set RF off
- #00R1\* to set RF on
- #00?r\* request to send back to PC the RF status.

Caro cliente

grazie per aver acquistato un prodotto NARDA! Sei in possesso di uno strumento che per molti anni ti garantirà un'alta qualità di servizio. NARDA riconosce l'importanza del Cliente come ragione di esistenza; ciascun commento e suggerimento, sottoposto all'attenzione della nostra organizzazione, è tenuto in grande considerazione. La nostra qualità è alla ricerca del miglioramento continuo. Se uno dei Suoi strumenti NARDA necessita di riparazione o calibrazione, può aiutarci a servirla più efficacemente compilando questa scheda e accludendola all'apparecchio.

Tuttavia, anche questo prodotto diventerà obsoleto. In questo caso, ti ricordiamo che lo smaltimento dell'apparecchiatura deve essere fatto in conformità con i regolamenti locali. Questo prodotto è conforme alle direttive WEEE dell'Unione Europea (2002/96/EC) ed appartiene alla categoria 9 (strumenti di controllo). Lo smaltimento, in un ambiente adeguato, può avvenire anche attraverso la restituzione del prodotto alla NARDA senza sostenere alcuna spesa. Può ottenere ulteriori informazioni contattando i venditori NARDA o visitando il nostro sito Web [www.narda-sts.it](http://www.narda-sts.it).

Dear Customer

thank you for purchasing a NARDA product! You now own a high-quality instrument that will give you many years of reliable service. NARDA recognizes the importance of the Customer as reason of existence; in this view, any comment and suggestion you would like to submit to the attention of our service organization is kept in great consideration. Moreover, we are continuously improving our quality, but we know this is a never ending process. We would be glad if our present efforts are pleasing you. Should one of your NARDA equipment need service you can help us serve you more effectively filling out this card and enclosing it with the product. Nevertheless, even this product will eventually become obsolete. When that time comes, please remember that electronic equipment must be disposed of in accordance with local regulations. This product conforms to the WEEE Directive of the European Union (2002/96/EC) and belongs to Category 9 (Monitoring and Control Instruments). You can return the instrument to us free of charge for proper environment friendly disposal. You can obtain further information from your local NARDA Sales Partner or by visiting our website at [www.narda-sts.it](http://www.narda-sts.it).

**Servizio richiesto:**  *Service needed:*

Solo taratura     Riparazione     Riparazione & Taratura     Taratura SIT     Altro:  
 Calibration only     Repair     Repair & Calibration     Certified Calibration     Other:

**Ditta:**

*Company:*

**Indirizzo:**

*Address:*

**Persona da contattare:**

*Technical contact person:*

**Telefono:**

*Phone n.*

**Modello:**

*Equipment model:*

**Numero di serie:**

*Serial n.*

**Accessori ritornati con l'apparecchiatura:**  **Nessuno**     **Cavo(i)**     **Cavo di alimentazione**    **Altro:**  
 *Accessories returned with unit:*     **None**     **Cable(s)**     **Power cable**    **Other:**

**Sintomi o problemi osservati:**  *Observed symptoms / problems:*

**Guasto:**  **Fisso**     **Intermittente**    **Sensibile a :**  **Freddo**     **Caldo**     **Vibrazioni**     **Altro**  
 *Failure:*  **Continuous**     **Intermittent**    **Sensitive to:**  **Cold**     **Heat**     **Vibration**     **Other**

**Descrizione del guasto/condizioni di funzionamento:**

*Failure symptoms/special control settings description:*

**Se l'unità è parte di un sistema descriverne la configurazione:**

*If unit is part of system please list other interconnected equipment and system set up:*

